

NOMINAL DIMENSIONS IN MM (IN.)

OEM P/N	SIZE	ØA	B	ØC	COMPATIBLE VALVE	DIAPHRAGM DIRECT P/N
NA12	050	34,0 (1,339)	16,0 (0,630)	18,0 (0,709)	NU050	DD12-NAWSRD-A
NA18	075	46,5 (1,831)	22,5 (0,886)	25,0 (0,984)	NU075	DD18-NAWSRD-A
NA25	100	62,0 (2,441)	28,0 (1,102)	34,0 (1,339)	NU100	DD25-NAWSRD-A
NA38	150	75,0 (2,953)	41,0 (1,614)	48,0 (1,890)	NU150	DD38-NAWSRD-A
NA51	200	97,0 (3,819)	51,0 (2,008)	64,0 (2,520)	NU200	DD51-NAWSRD-A

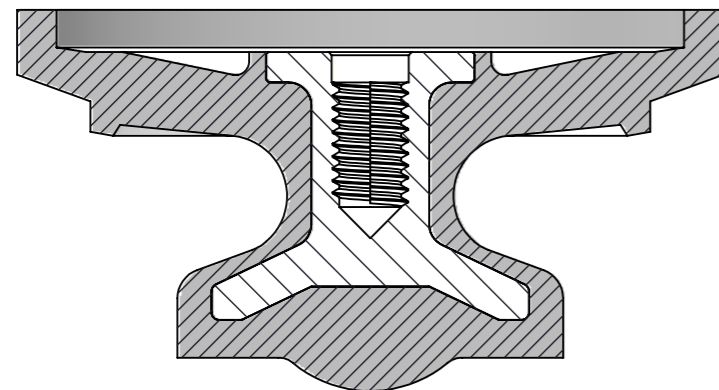
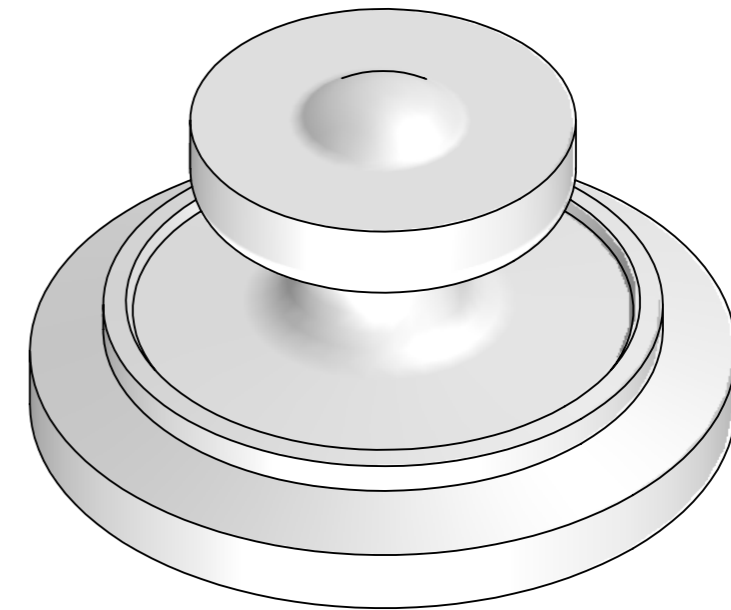
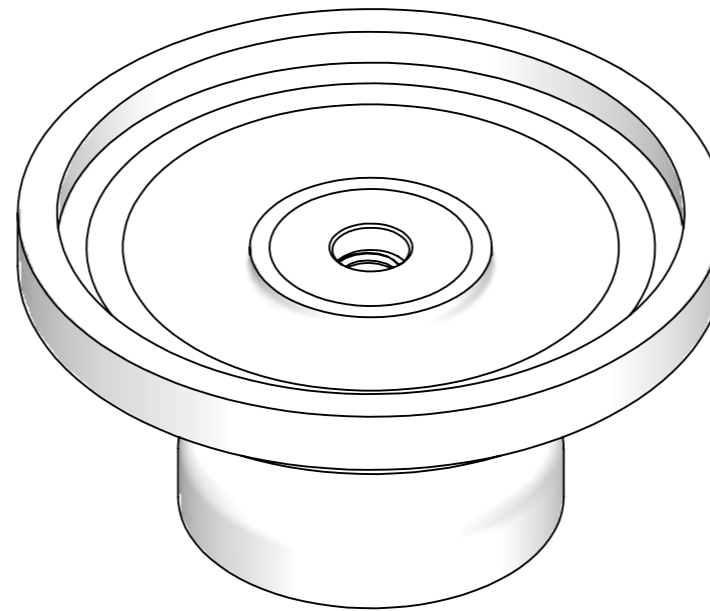
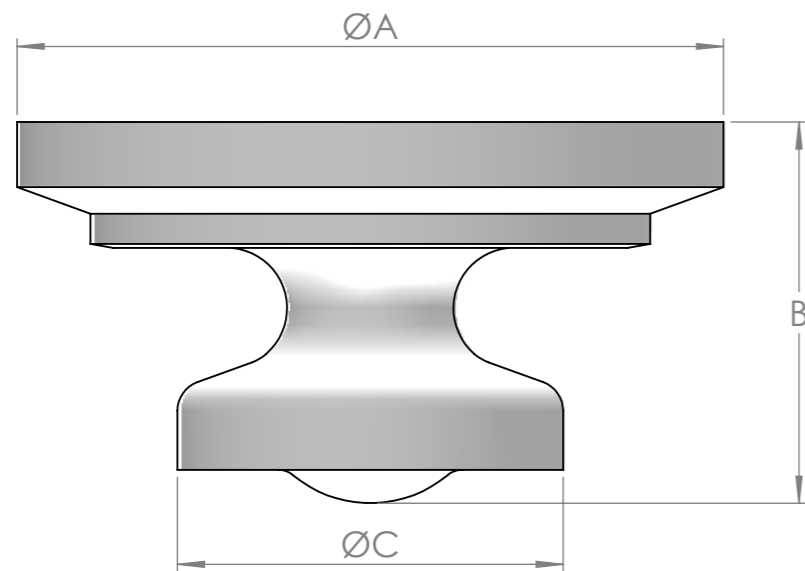

SECTION VIEW

REPLACEMENT DIAPHRAGM FOR OEM P/N: NA18
MATERIAL ELASTOMER: PLAT. SILICONE WHITE
MATERIAL METAL STEM: 316SS

Complies with CFR 177.2600
 and Conforms to
 USP Class VI Biological
 Reactivity
 Tests Section #87 and #88

UP Ultrapharma

info@ultrapharma.com De Droogmakerij 12 The Netherlands
 www.ultrapharma.com 1851LX Heiloo Tel.: +31 856 200 900

CONFIGURATION PLAT. SILICONE WHITE	DESCRIPTION: DIAPHRAGM NA18 3/4" ASSEMBLY	3RD ANGLE PROJECTION	UNITS: mm	SCALE: 2:1	SHEET SIZE A3
The information contained in this drawing is the sole property of Ultrapharma BV. Any reproduction in part or as a whole without written permission of Ultrapharma BV is prohibited.					